

REVISIONS		
DATE	NAME	NO.
Aug. 2008	Dixon Assoc.	1
Nov. 15, 2010	Dixon Assoc.	2

REVISIONS TO THIS MAP
HAVE BEEN MADE BY
DANIEL J. GALLETTA, P.L.S.
N.J. LIC. NO. 25050
DIXON ASSOCIATES ENGINEERING, LLC
3115 JAMES LEE ROAD
SUITE 200
GALLOWAY, N.J. 08045
TEL: 609.666.7111 FAX: 609.666.7112
WWW.DIXONASSOCIATES.COM
DATE: 11/15/12

SHEET 16

AVE. ROAD

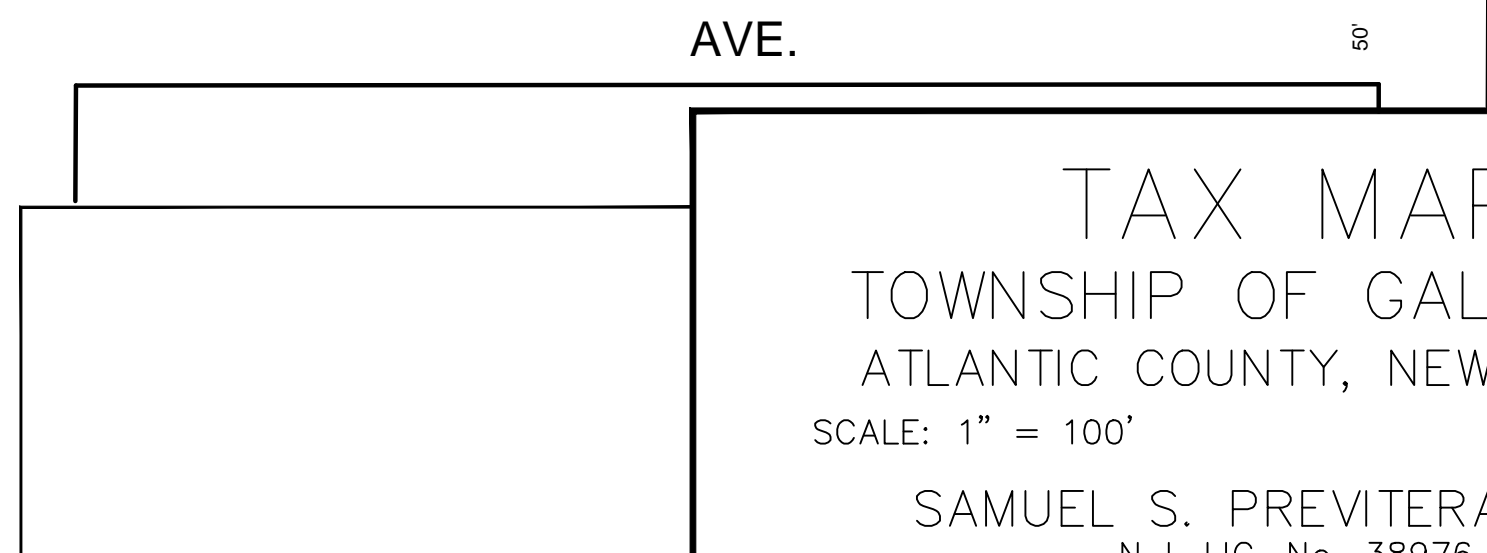
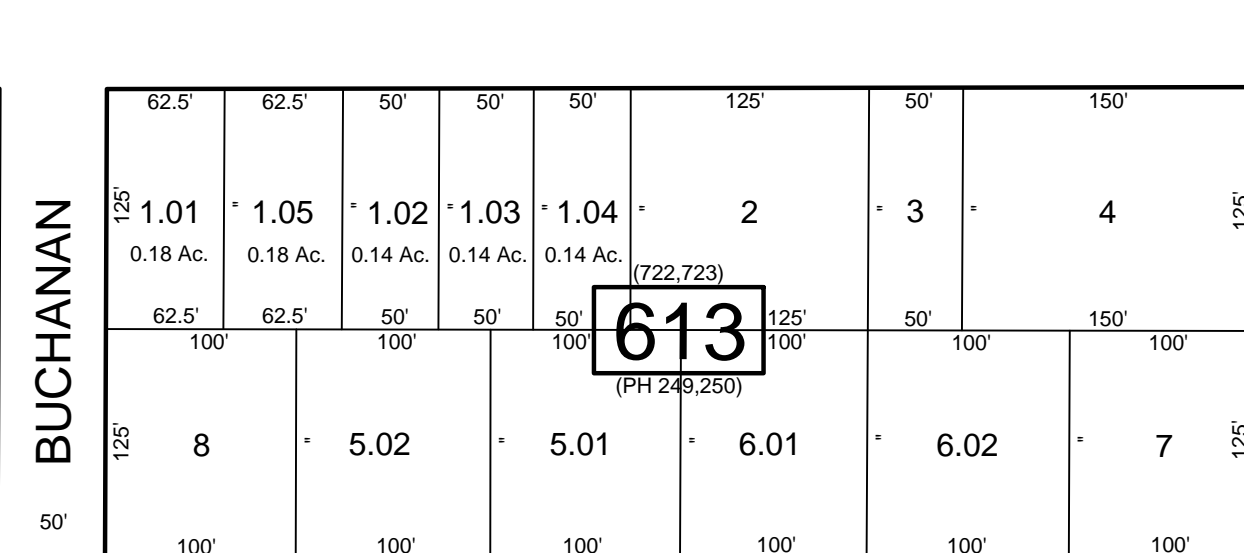
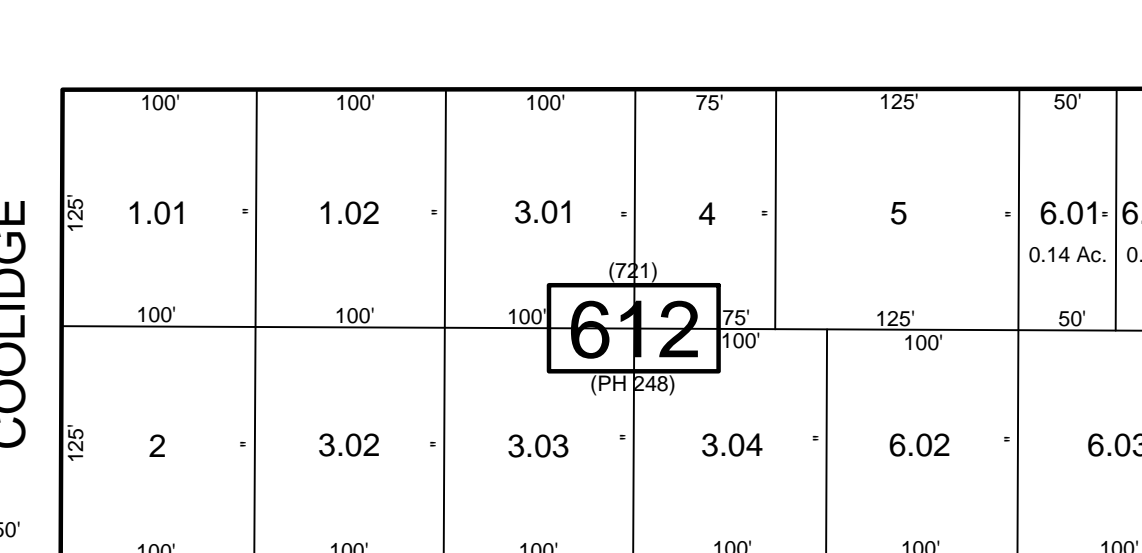
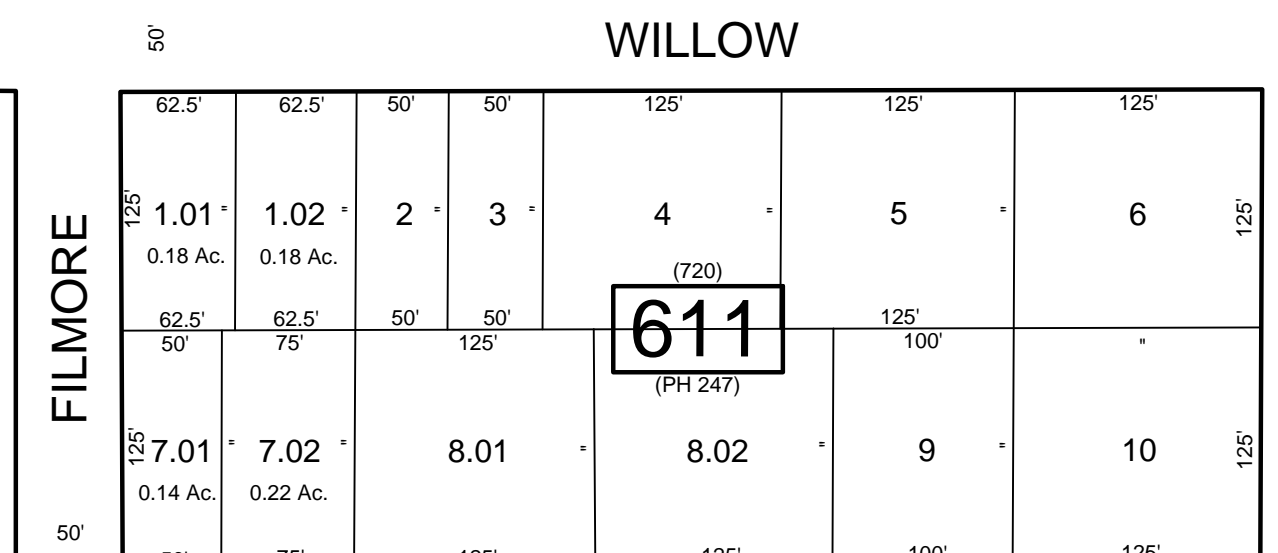
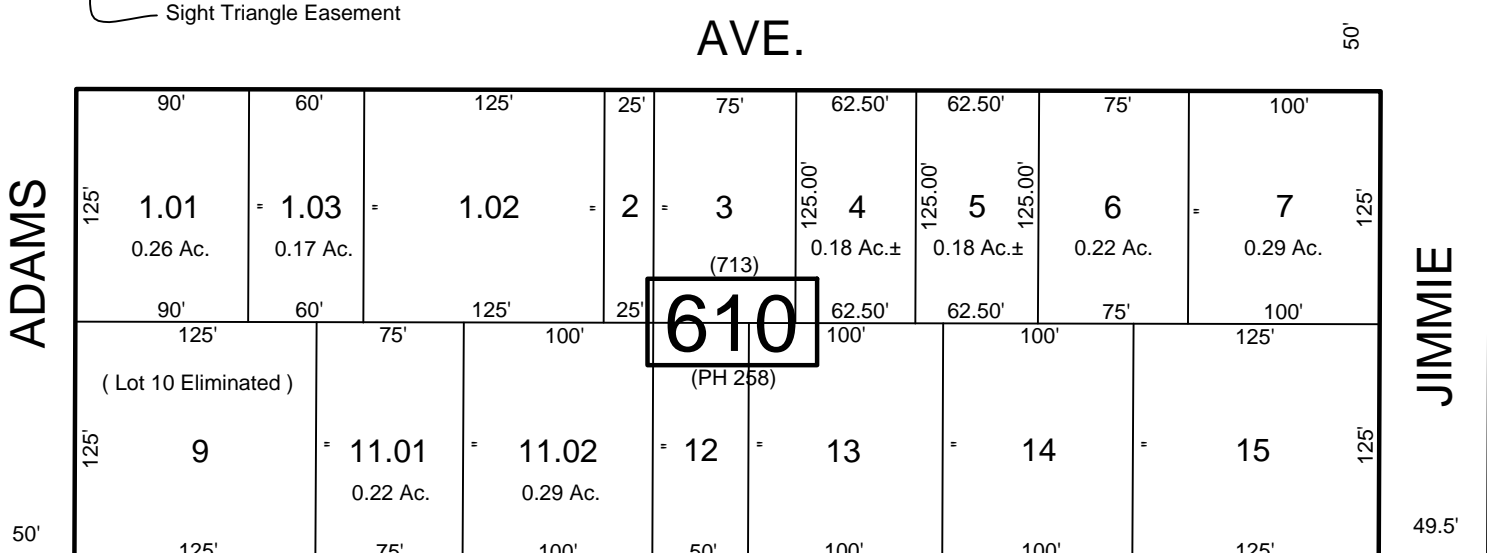
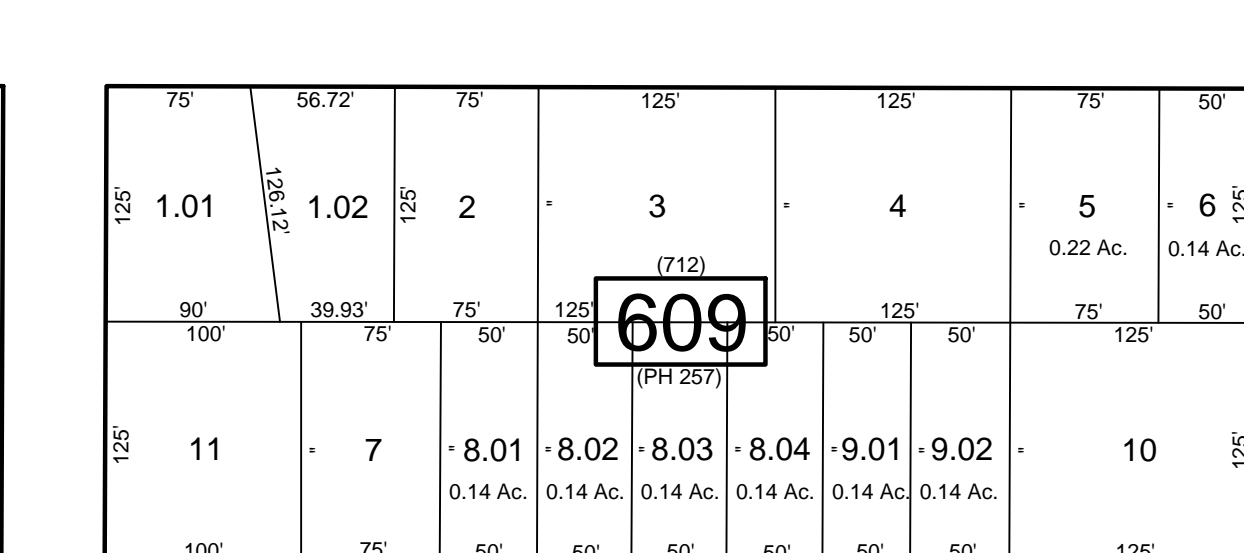
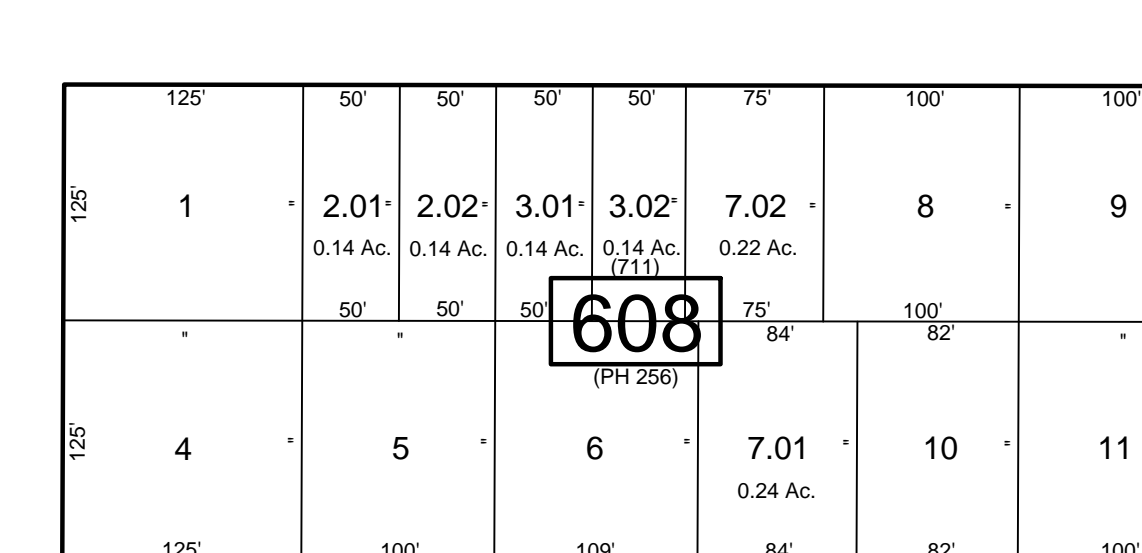
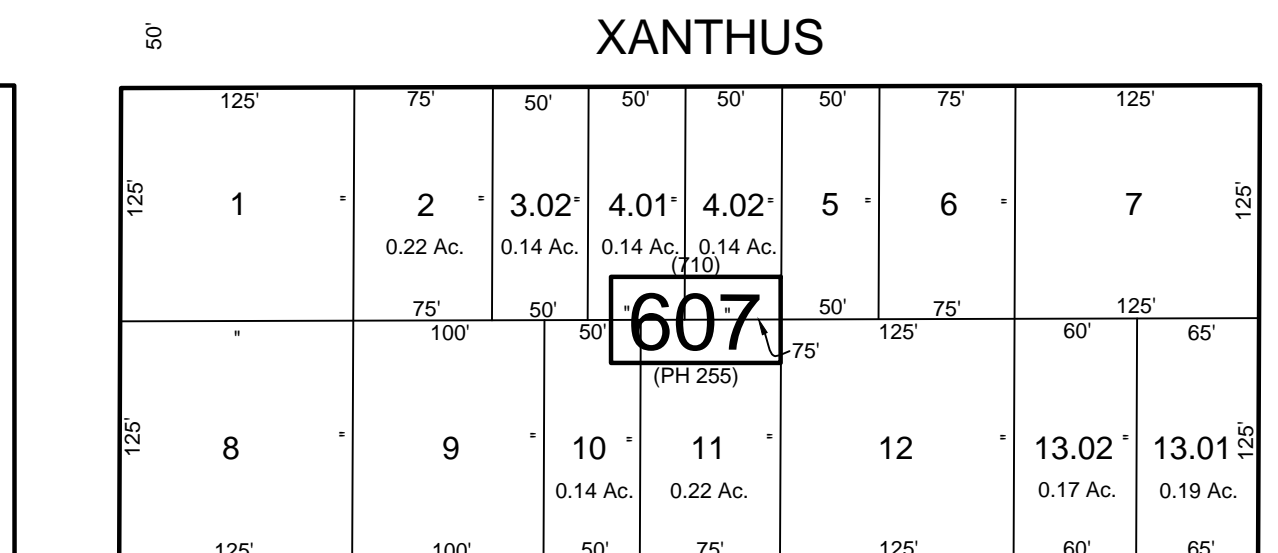
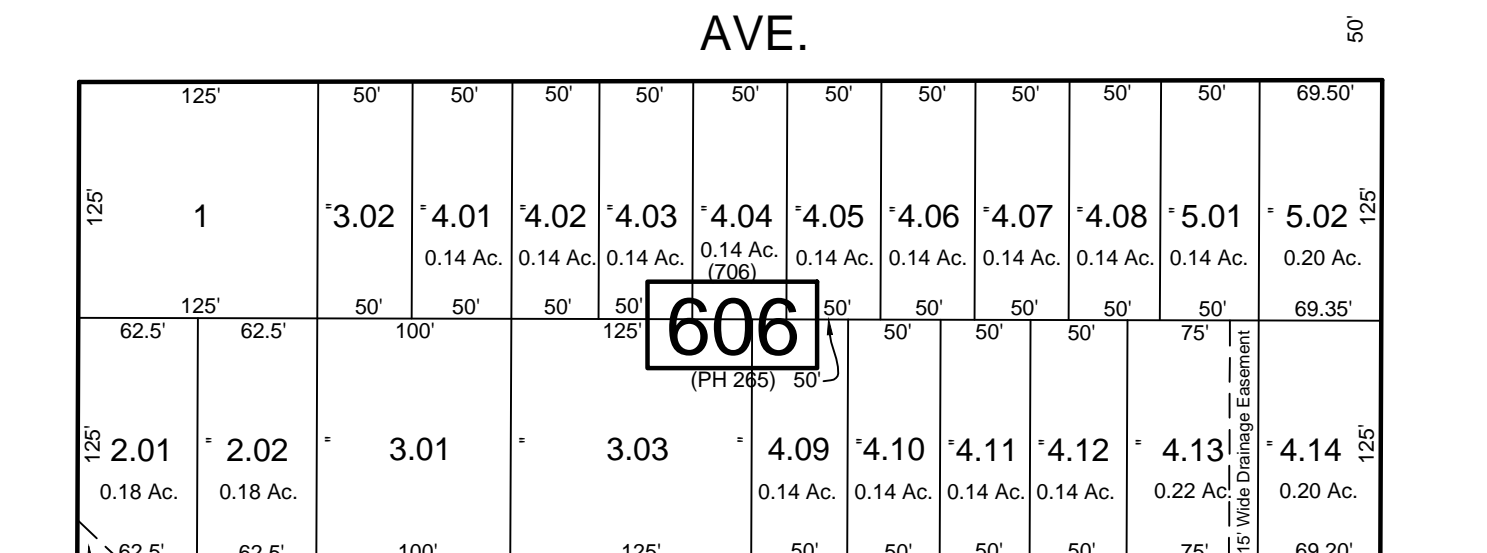
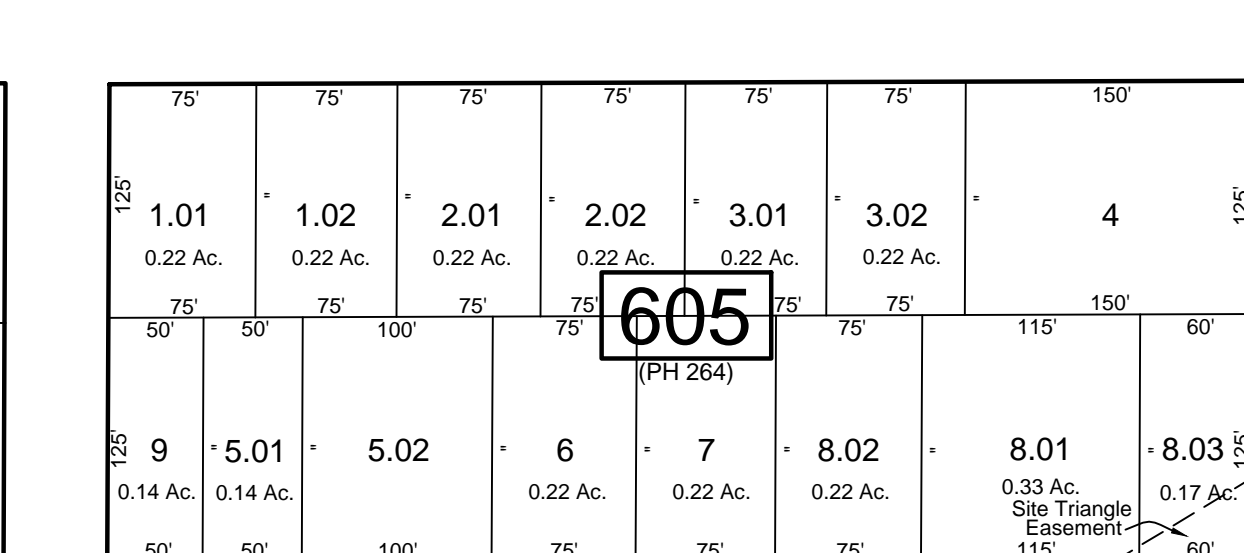
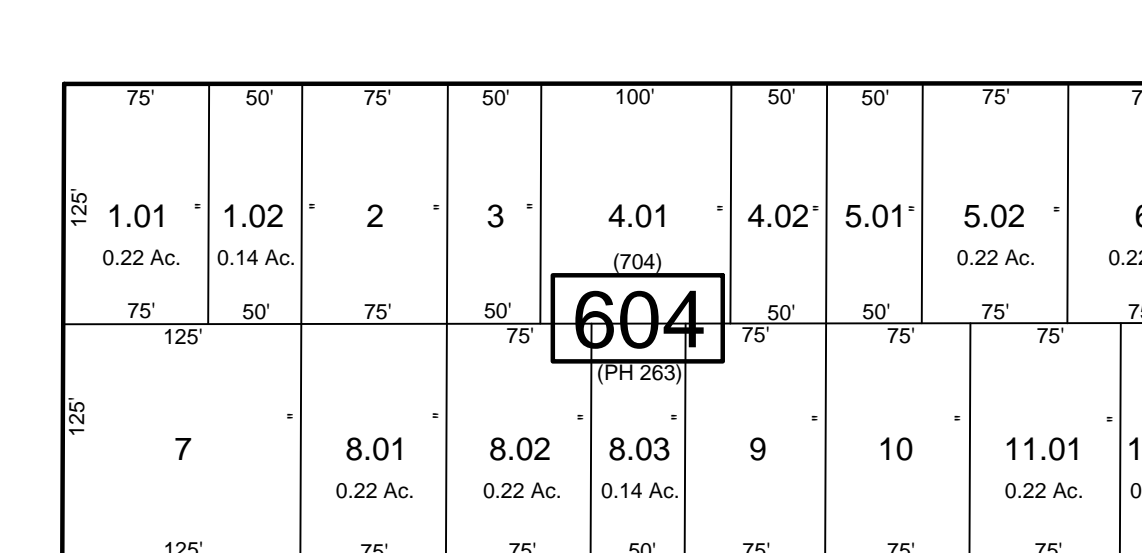
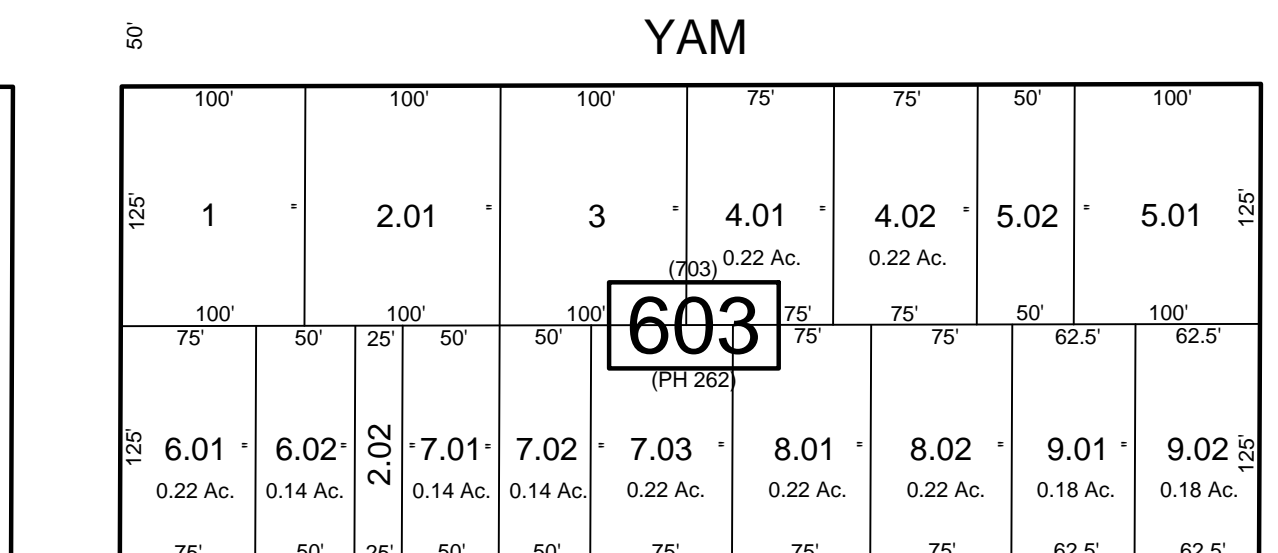
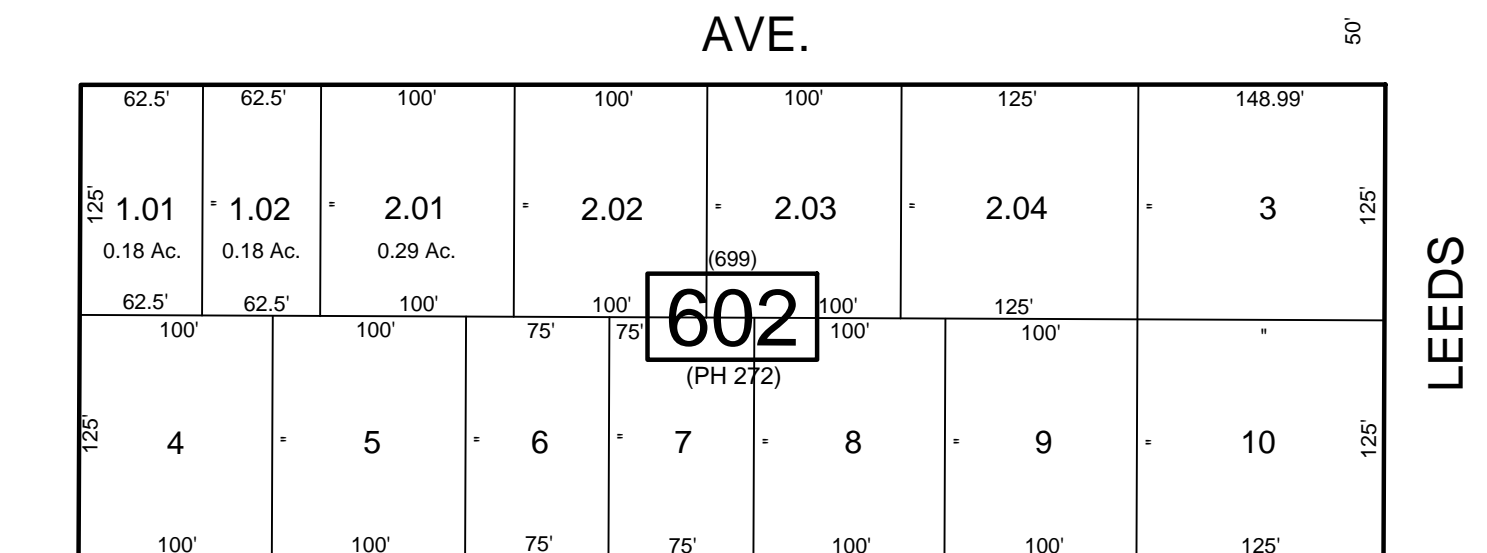
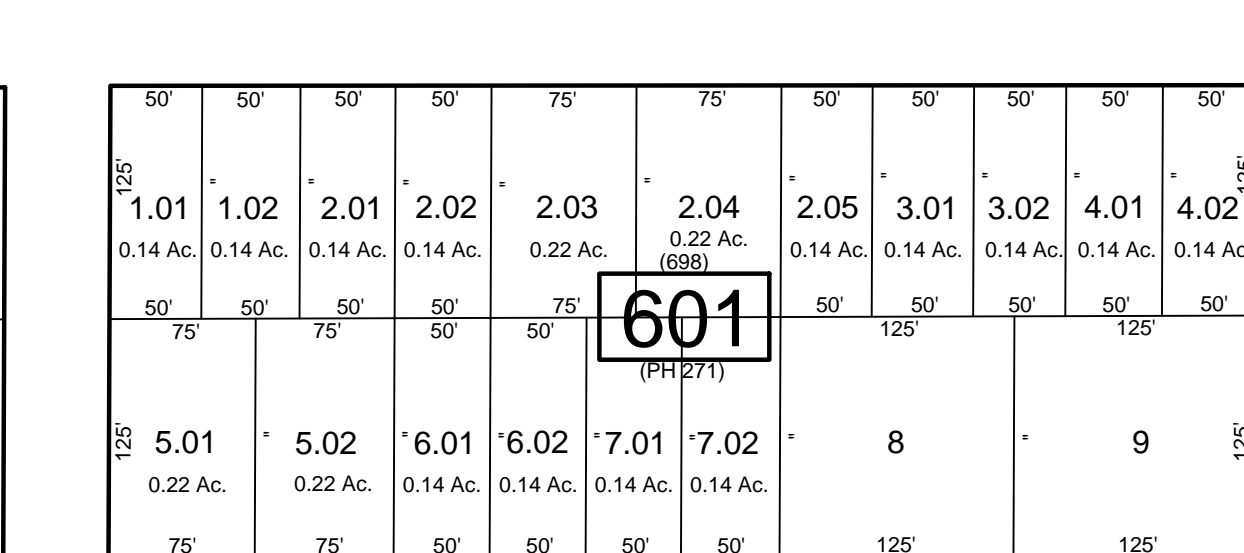
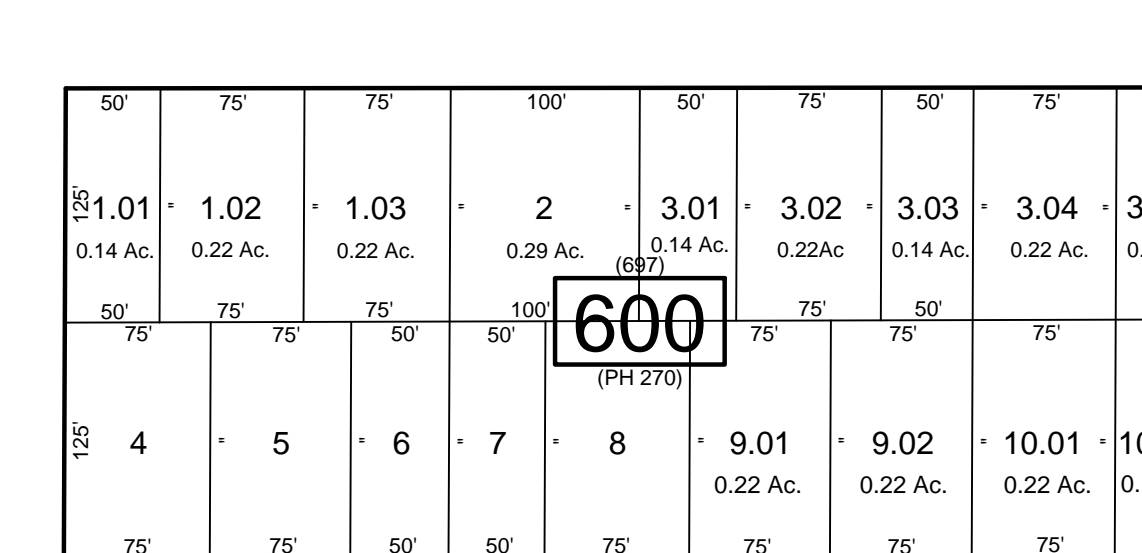
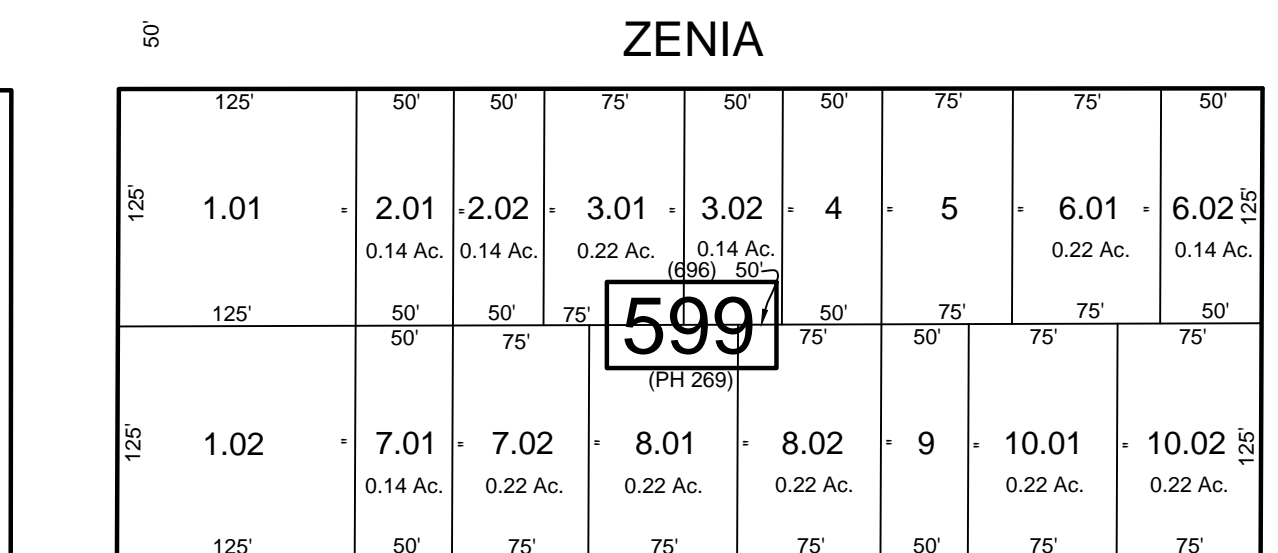
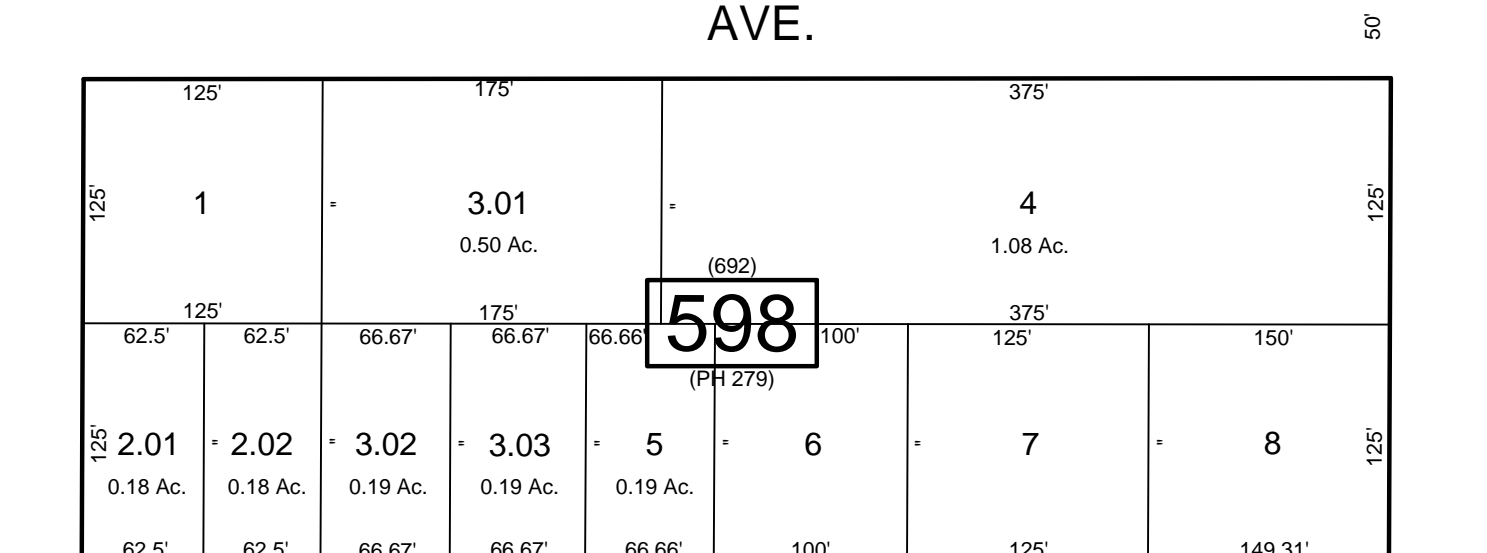
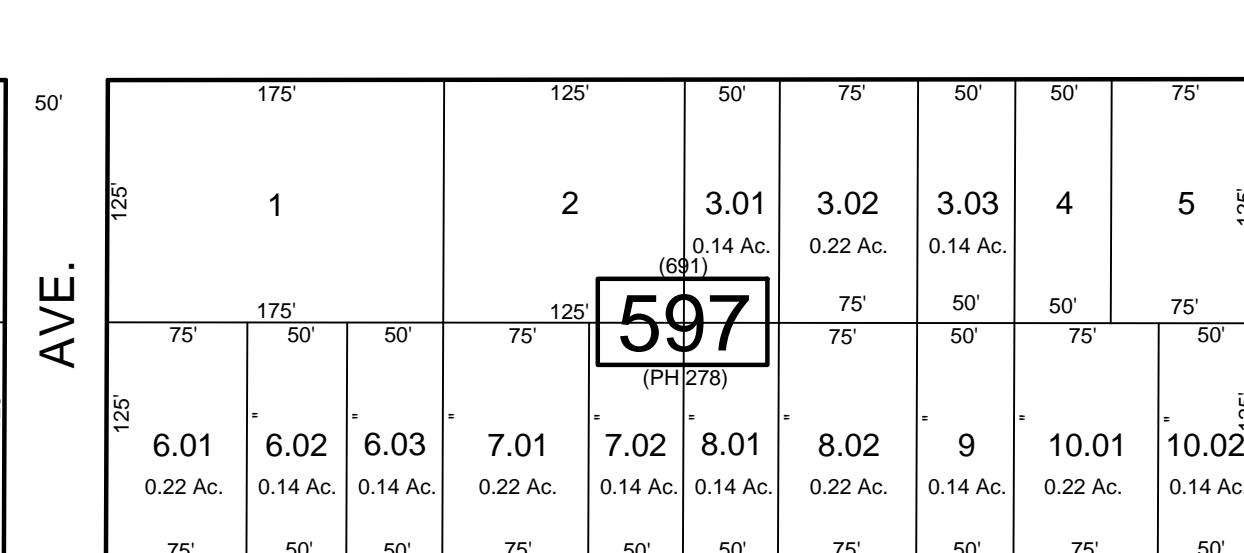
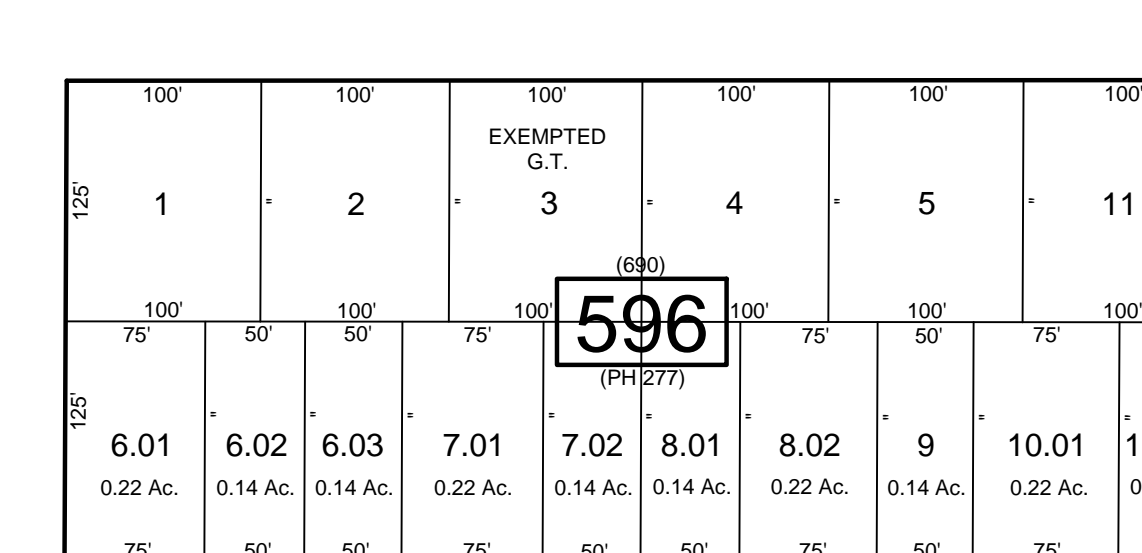
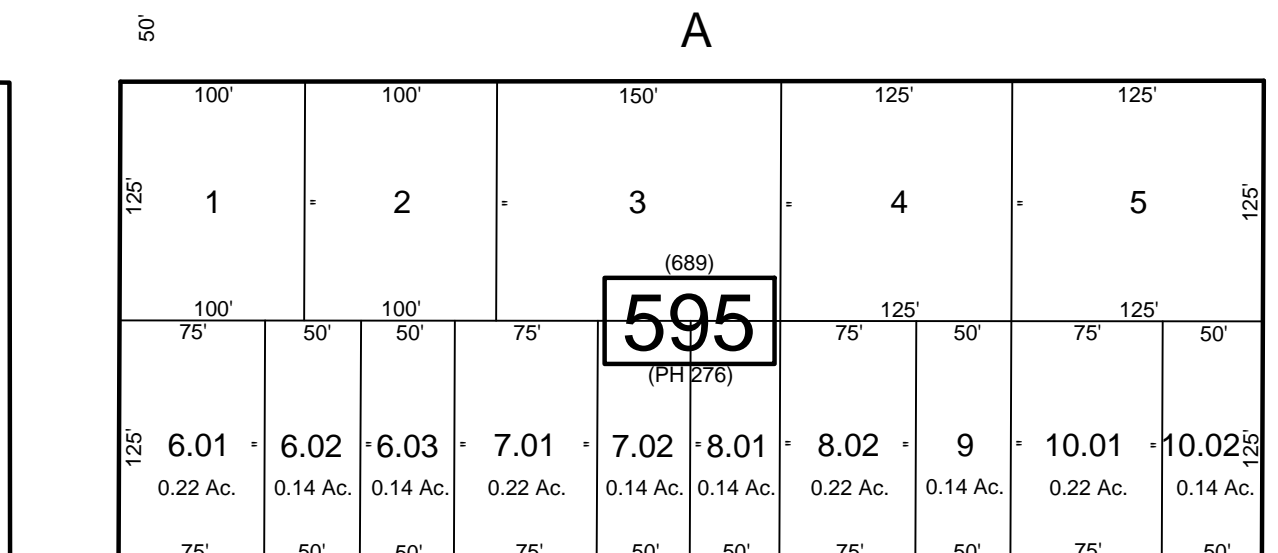
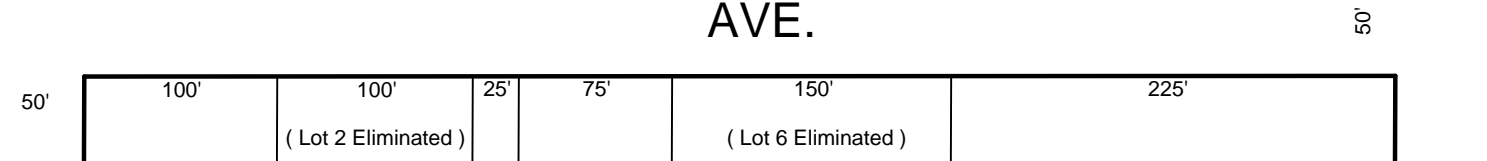
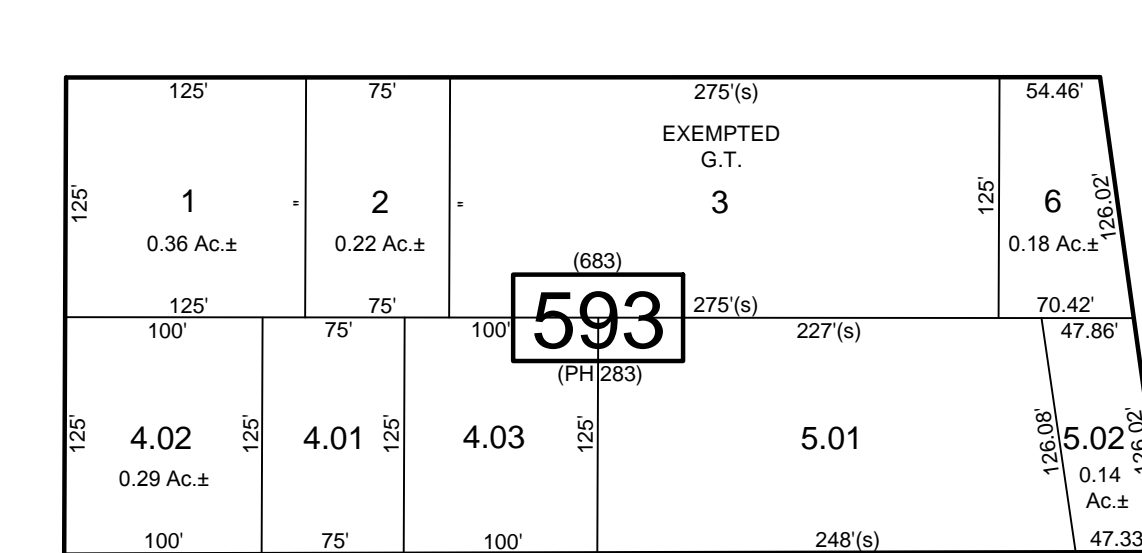
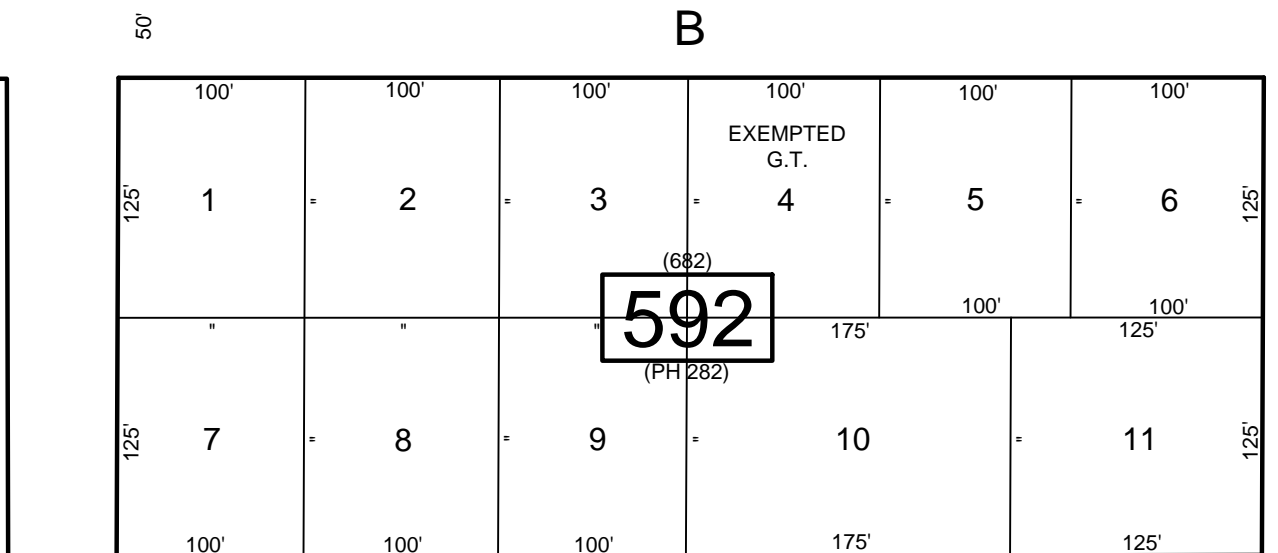
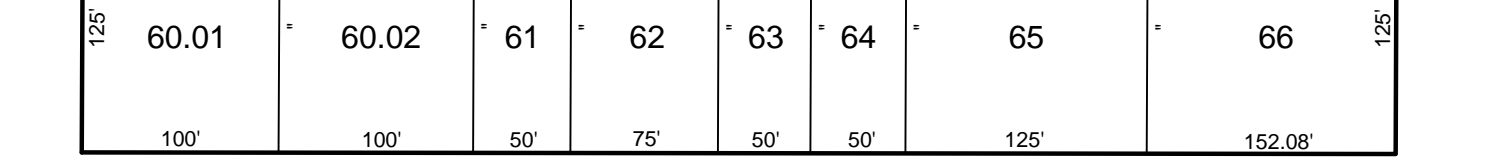
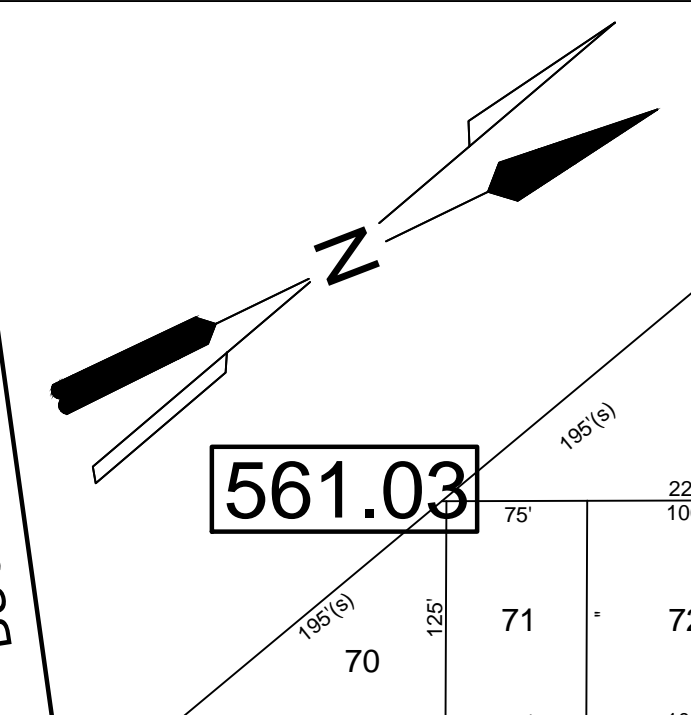
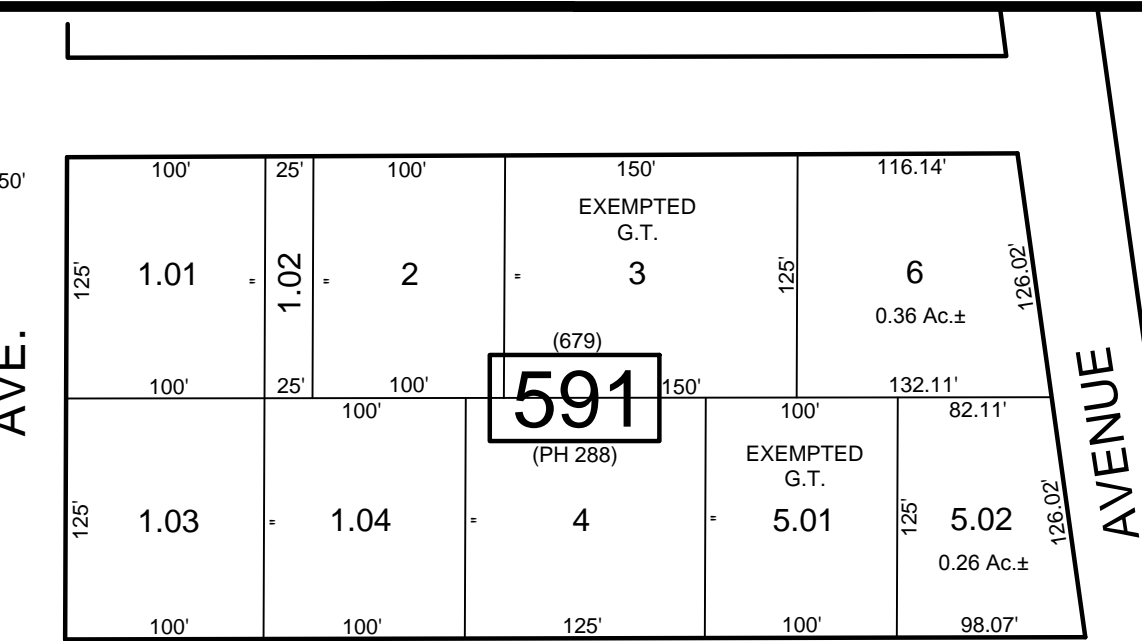
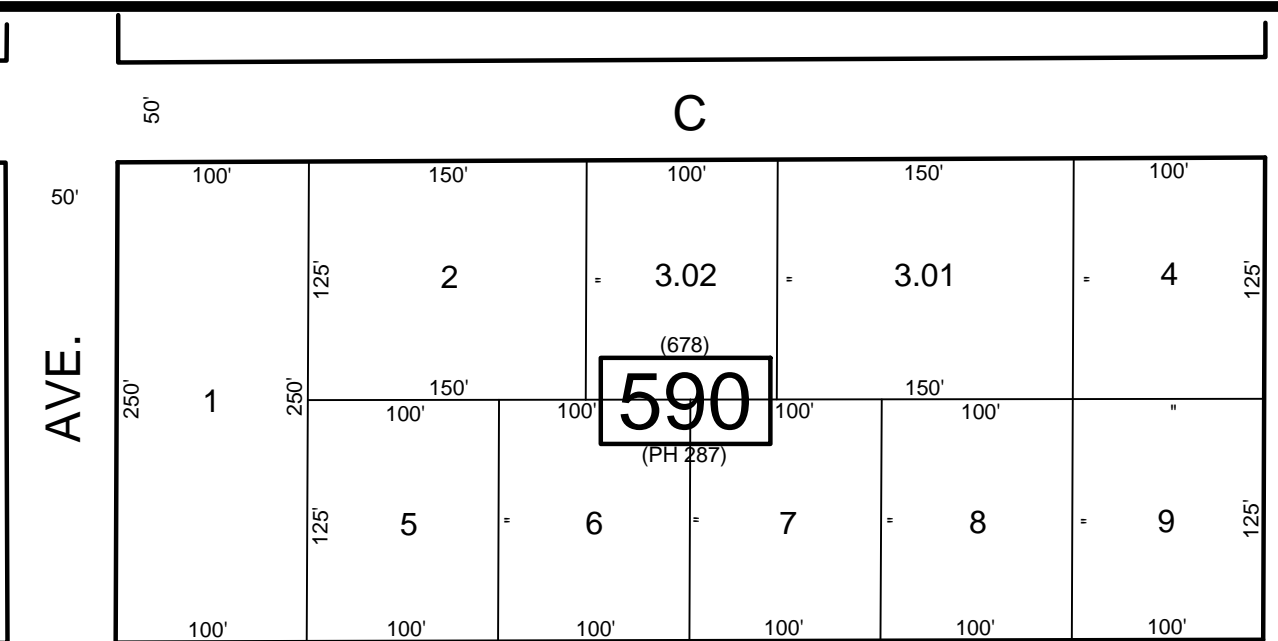

NOTE:
LETTERS "PH" INDICATES NUMBERS ON MAP OF "PINEHURST" BY PINEHURST DEV. CO.
LETTERS "G.T." INDICATES GALLOWAY TOWNSHIP OWNED PROPERTY.

THIS SHEET HAS BEEN DRAWN USING COMPUTER AIDED DRAFTING / DESIGN (CAD/D)
AND WAS DONE UNDER THE SUPERVISION OF SAMUEL S. PREVITERA, P.L.S., NEW JERSEY
PROFESSIONAL LAND SURVEYOR LICENSE NO. 38976, AND DATED DECEMBER 31, 2006.

TAX MAP
TOWNSHIP OF GALLOWAY
ATLANTIC COUNTY, NEW JERSEY
SCALE: 1" = 100'
JANUARY 2007
SAMUEL S. PREVITERA, P.L.S.
N.J. LIC. No. 38976
26 NORTH ROUTE 73, SUITE 200
CEDAR BROOK, N.J. 08018

SHEET 16.01

SHEET 16

LEEDS

JIMMIE